

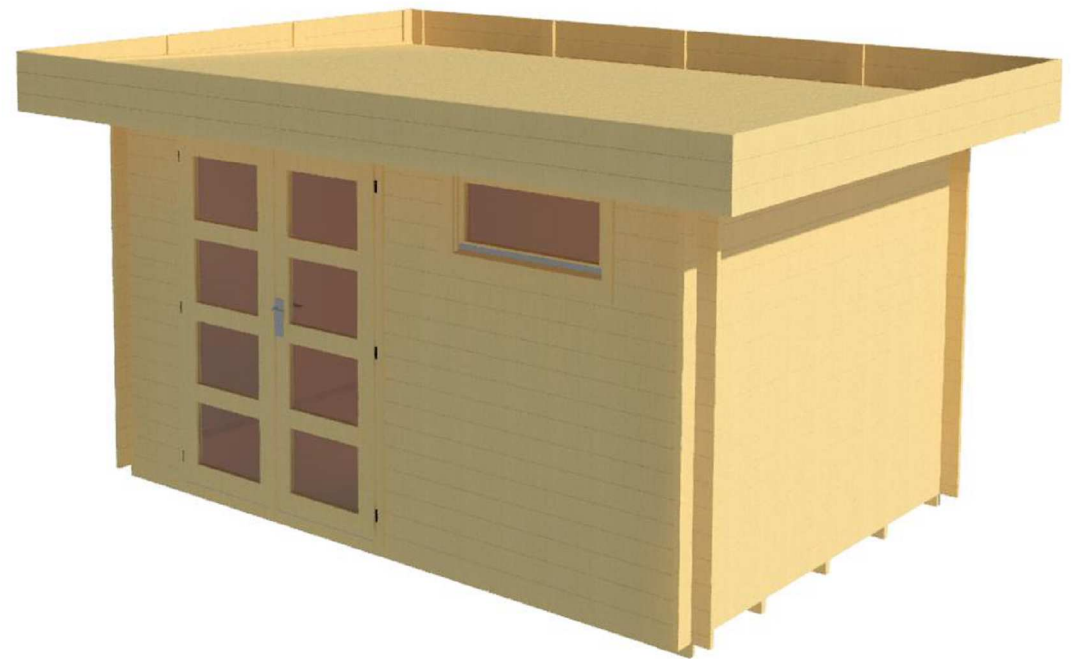

Christina 28 (370x250)

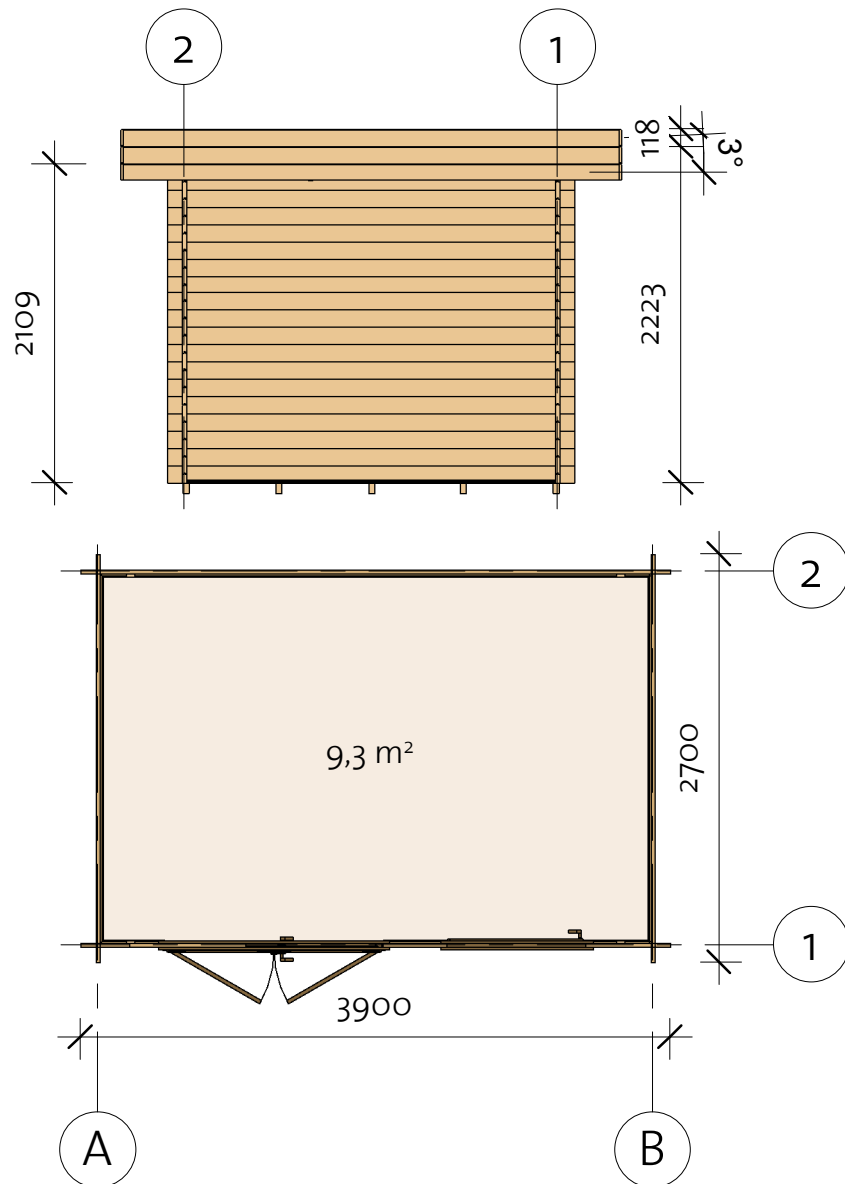

Christina 28 (370x250)

Foundation

Impregnated foundation beams				
Mark	Type	Profile	Count	Length

IFB	IFB 40x70		5	3690
-----	--------------	---	---	------

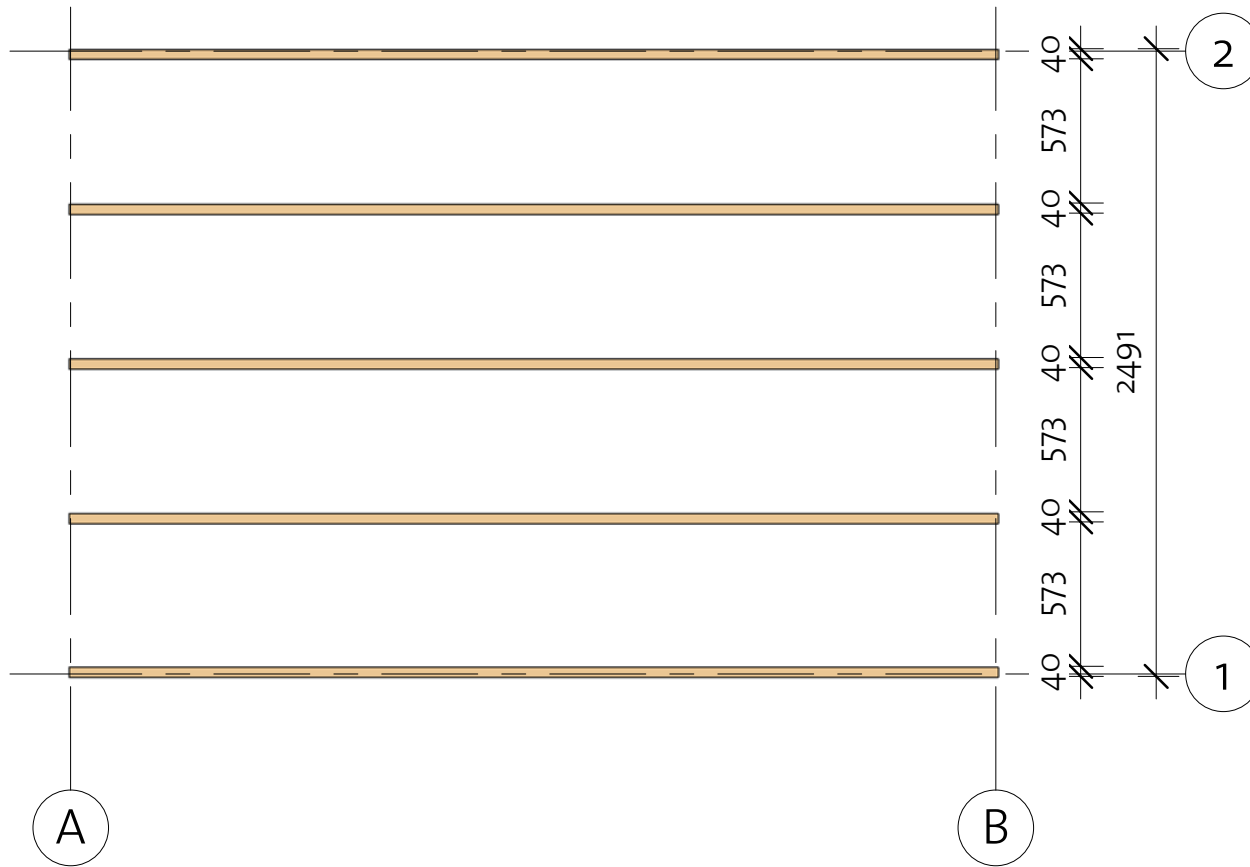



Christina 28 (370x250)

Floor Plan

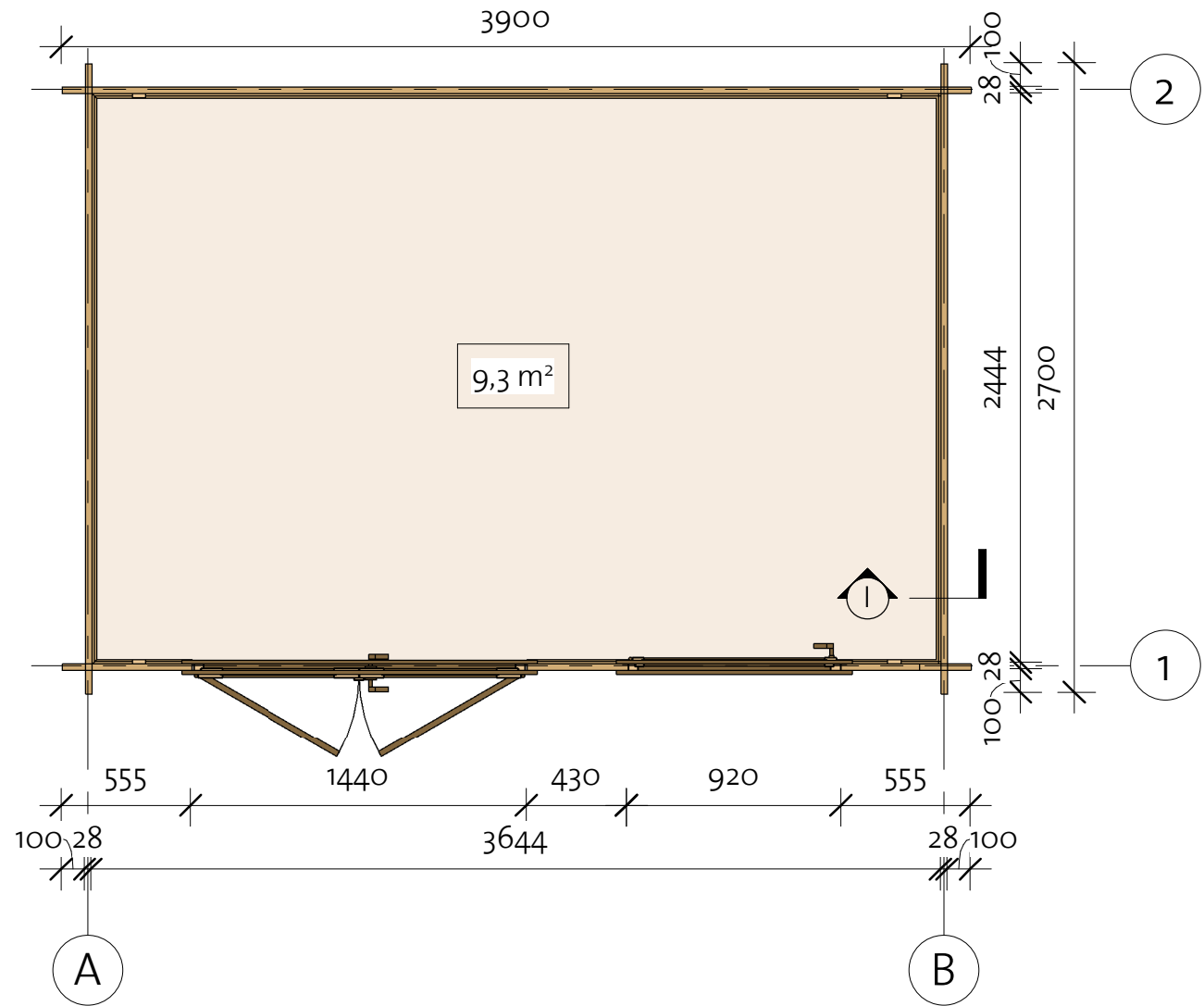
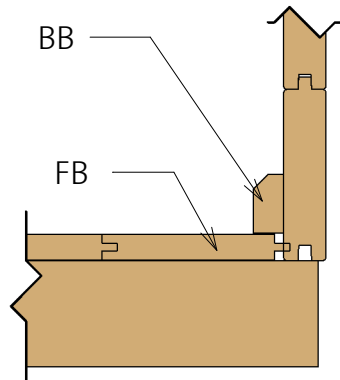
① Baseboard



Floor Schedule

Mark	Type	Profile	Count	Length
FB	FB 17x114		33	2440
BB1	BB 20x40		2	2500
BB2	BB 20x40		2	3700

4000010_210521

Christina 28 (370x250)

Wall 1

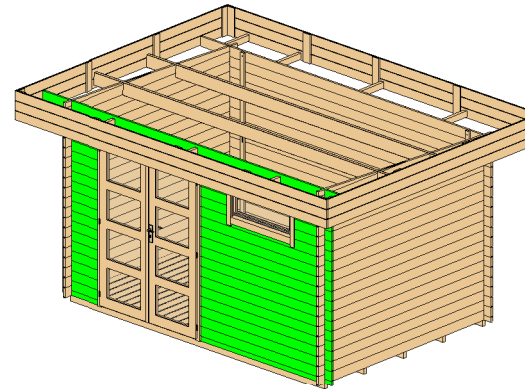

Wall 1			
Mark	Profile	Count	Cut Length

1BL 1	28x57	1	555
1BL 2	28x57	1	1905
1LG 1	28x114	4	430
1LG 2	28x114	21	555
1LG 3	28x114	13	1905
1LG 4	28x114	1	3900
1TL 1	28x114	1	4480

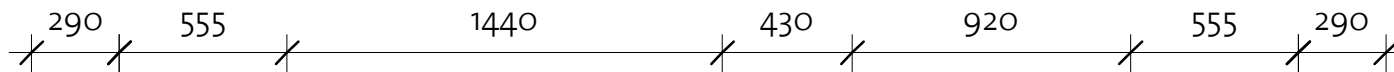
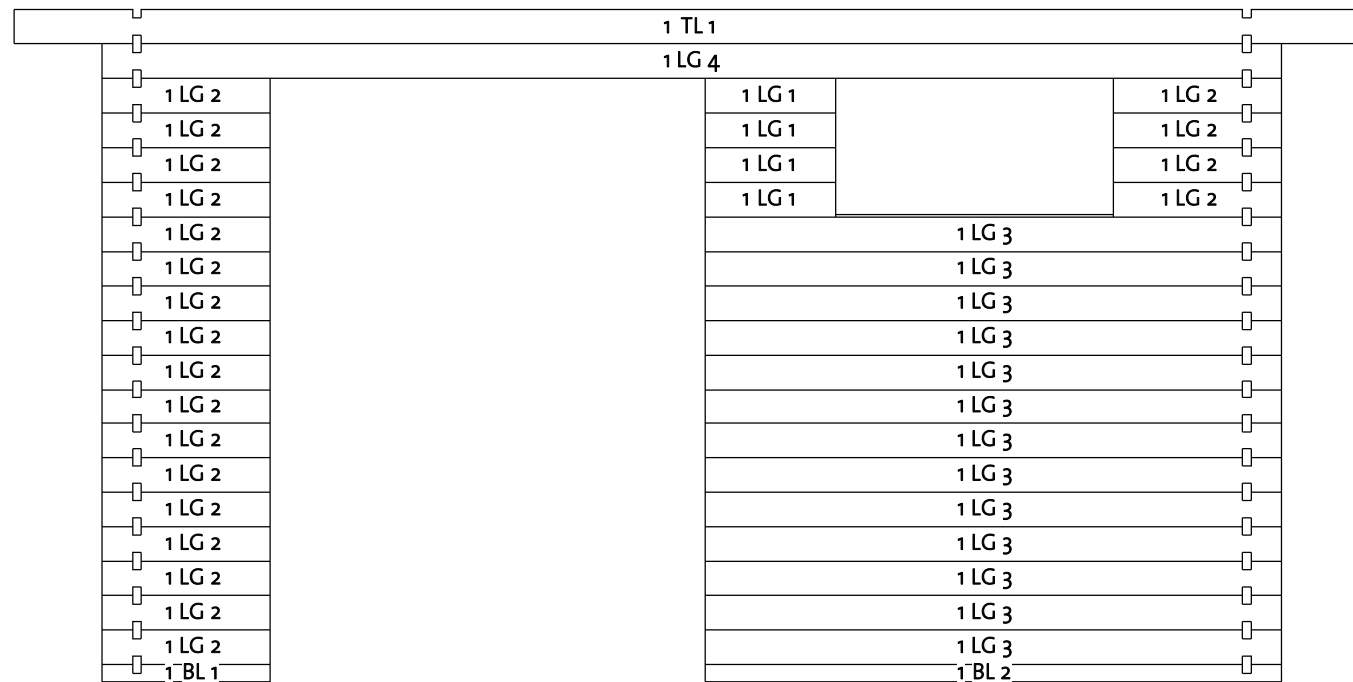

4000010_210521

Log Profile Wall 1	
Profile	Profile

28x114	
28x57	
28x114	

Christina 28 (370x250)

Wall A

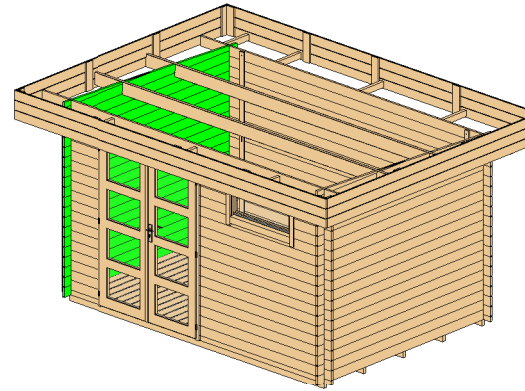

Wall A			
Mark	Profile	Count	Cut Length

ALG 1 *	28x114	1	1365
ALG 2 *	28x114	1	2700
ALG 3	28x114	17	2700
ALG 4 *	28x114	1	2700

* Gable - delivered premounted

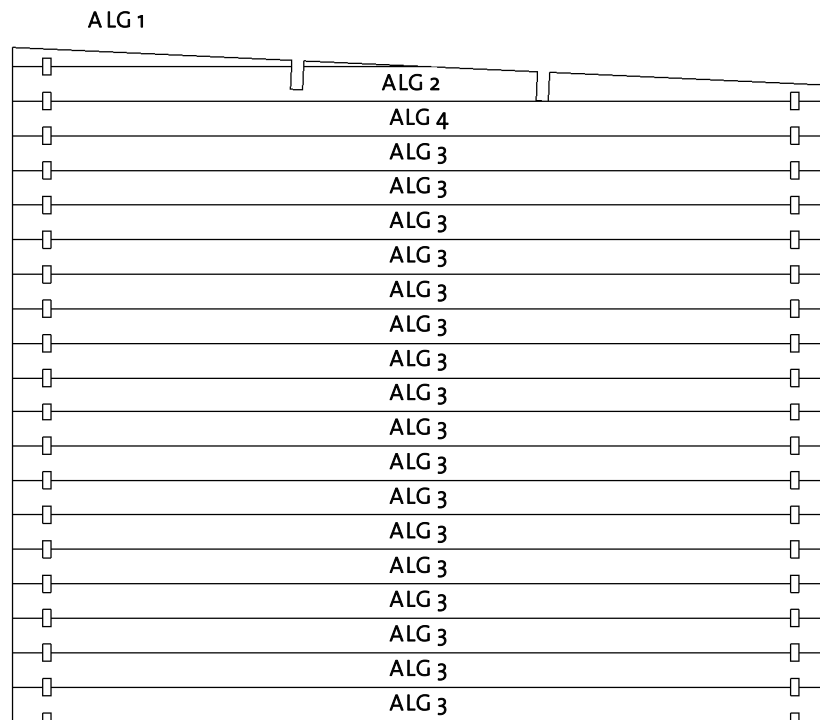

2700

4000010_210521

Log Profile Wall A	
Profile	Profile

28x114	
--------	--

Christina 28 (370x250)

Wall B

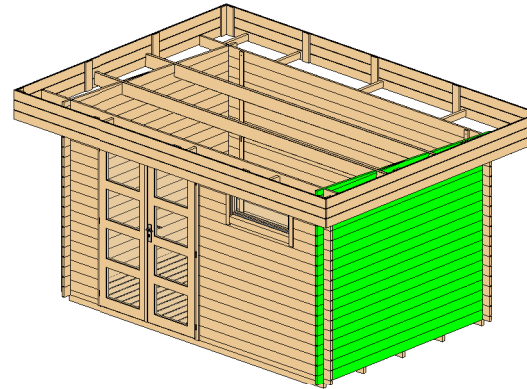

Wall B			
Mark	Profile	Count	Cut Length

BLG 1 *	28x114	1	1365
BLG 2 *	28x114	1	2700
BLG 3	28x114	17	2700
BLG 4 *	28x114	1	2700

* Gable - delivered premounted

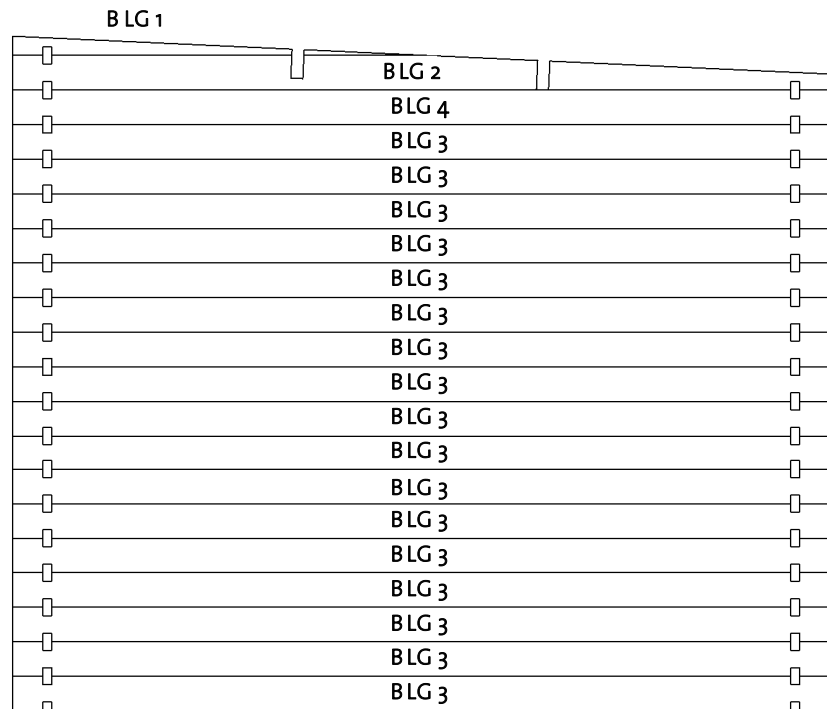

2700

Log Profile Wall B	
Profile	Profile

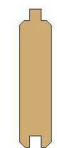

28x114



Christina 28 (370x250)

Roof 1

Roof				
Mark	Type	Profile	Count	Length

RB	17x114		40	3230
RE1	40x70		8	390
RFB	Beam 40x143		2	4480

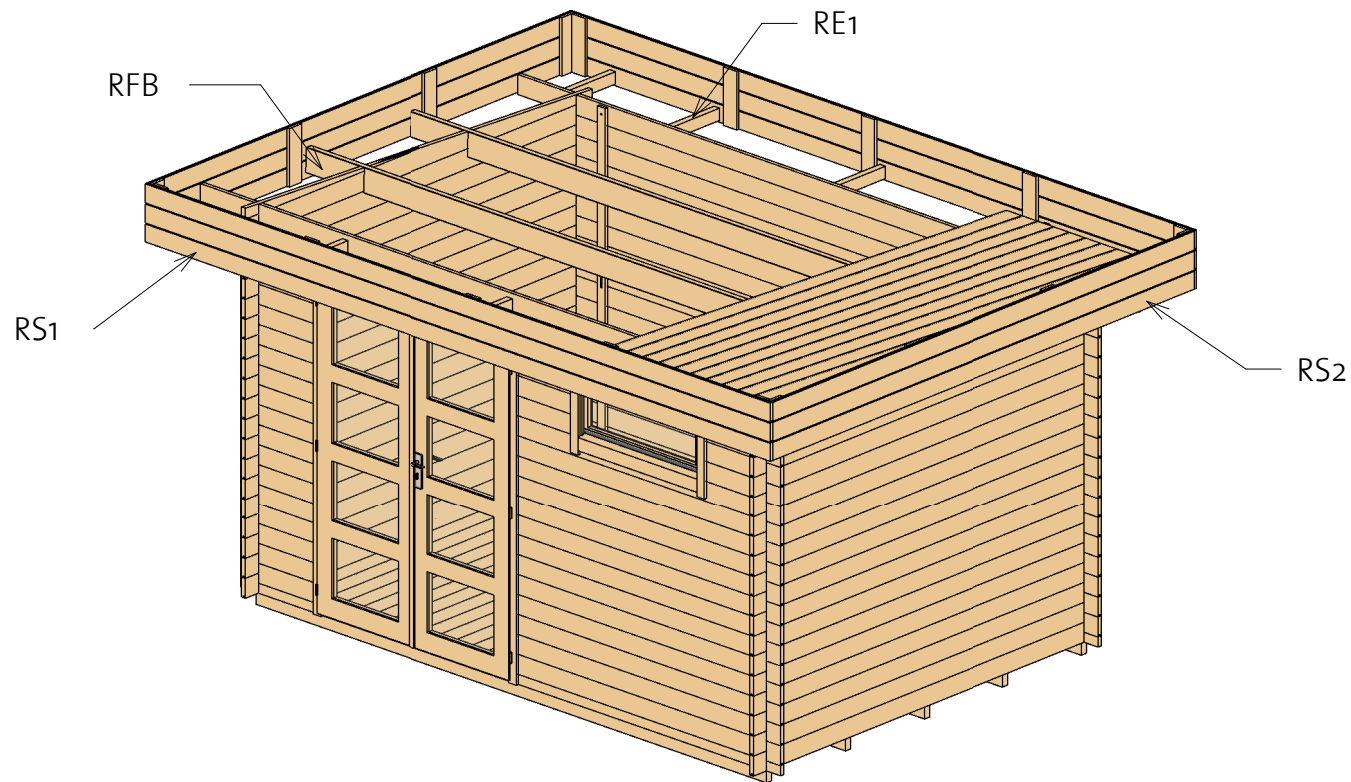

Roof Side Schedule		
Type	Length	Count

RS1	4516	2
RS2	3280	2

Christina 28 (370x250)

Roof 2

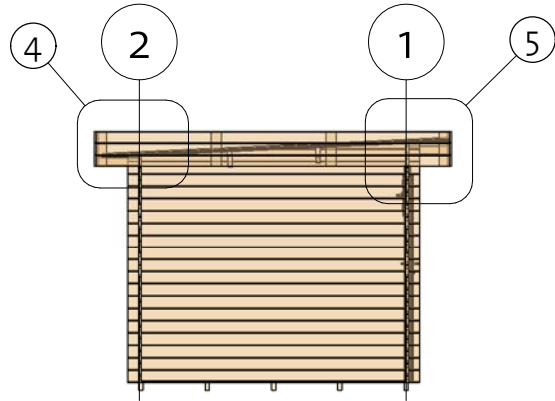

Fascia Schedule				
Mark	Type	Profile	Count	Length
EE1	Eave Edging 18x40		1	4444
EE2	Eave Edging 18x40		2	3172

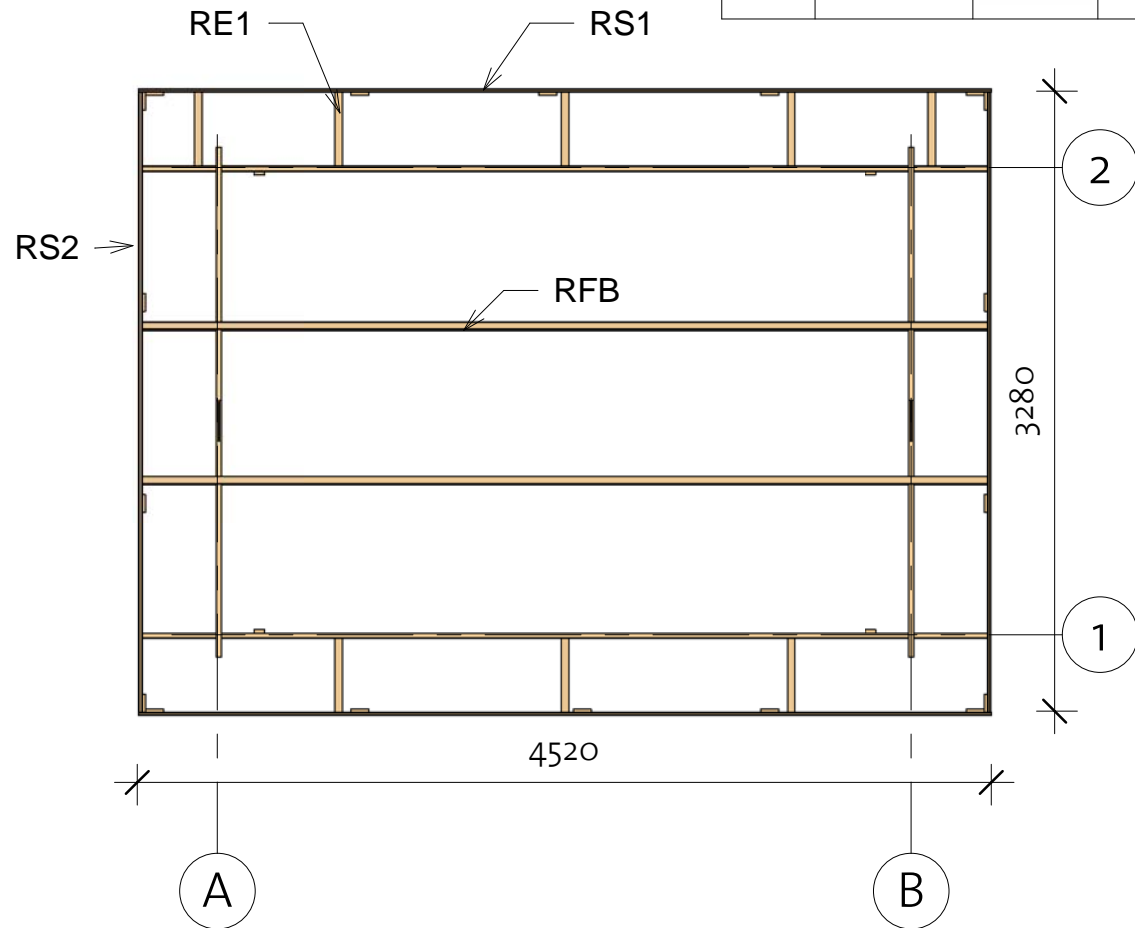
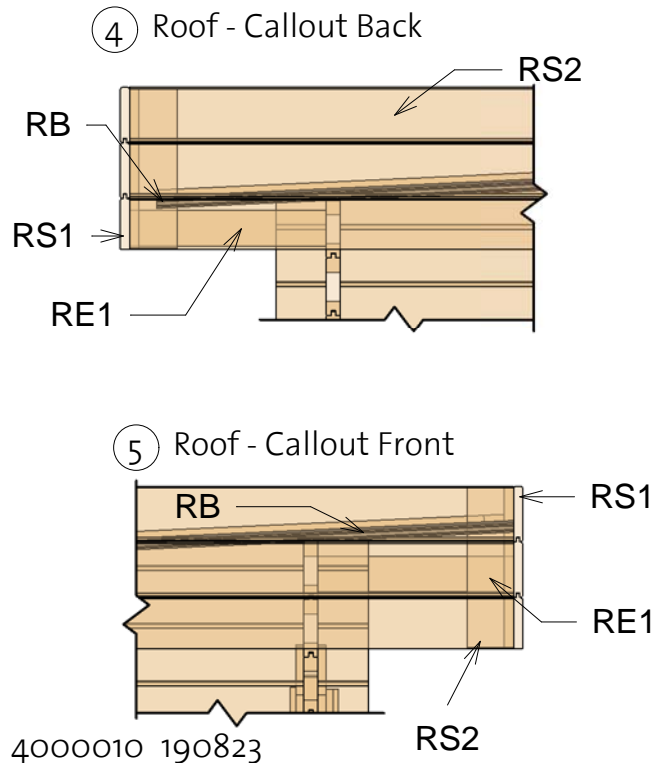

Christina 28 (370x250)

Extras

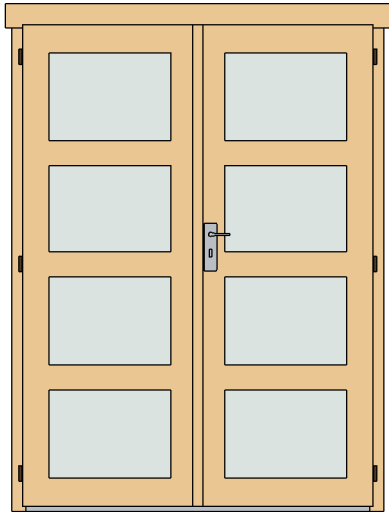

Door Schedule				
Model	Type	Width	Height	Count
BDD4R	Basic double door 4, four glass right	1425	1955	1

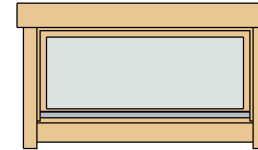

Window Schedule				
Model	Type	Width	Height	Count
BW2R	Basic window 2 right	915	420	1
WCB6	Window crossbar 6 optional	--	--	1

Fasteners & Extras		
Name	Comments	Count

Hitblock	300-400 mm	
Bolts	M8 x 60	12
Screws	5,0 x 70	25
Nails	1,4 x 40	30
Screws	6,0 x 140	80
Screws	4,0x40	400



Type	Count	Length
Windboard 18x40	4	2200

- * Windows intended for tilt opening only!
- * Fenster zur Eröffnung nur zum Kippen vorgesehen!
- * Aknad on ette nähtud ainult kaldu avamiseks!

4000010_210521

Christina 28 (370x250)

List of all items 1



Impregnated foundation beams

Mark	Type	Profile	Count	Length
------	------	---------	-------	--------

IFB	IFB 40x70		5	3690
-----	--------------	---	---	------

Roof

Mark	Type	Profile	Count	Length
------	------	---------	-------	--------

RB	17x114		40	3230
RE1	40x70		8	390
RFB	Beam 40x143		2	4480

Floor Schedule



Mark	Type	Profile	Count	Length
------	------	---------	-------	--------

FB	FB 17x114		33	2440
----	-----------	---	----	------

BB1	BB 20x40		2	2500
BB2	BB 20x40		2	3700

Fascia Schedule

Mark	Type	Profile	Count	Length
------	------	---------	-------	--------

EE1	Eave Edging 18x40		1	4444
EE2	Eave Edging 18x40		2	3172

Roof Side Schedule

Type	Length	Count
------	--------	-------

RS1	4516	2
RS2	3280	2

Christina 28 (370x250)

List of all items 2

Wall 1			
Mark	Profile	Count	Cut Length

1BL 1	28x57	1	555
1BL 2	28x57	1	1905
1LG 1	28x114	4	430
1LG 2	28x114	21	555
1LG 3	28x114	13	1905
1LG 4	28x114	1	3900
1TL 1	28x114	1	4480

Wall A			
Mark	Profile	Count	Cut Length

ALG 1 *	28x114	1	1365
ALG 2 *	28x114	1	2700
ALG 3	28x114	17	2700
ALG 4 *	28x114	1	2700

Wall 2			
Mark	Profile	Count	Cut Length



2BL 1	28x57	1	3900
2LG 1	28x114	17	3900
2TL 1	28x114	1	4480

Wall B			
Mark	Profile	Count	Cut Length

BLG 1 *	28x114	1	1365
BLG 2 *	28x114	1	2700
BLG 3	28x114	17	2700
BLG 4 *	28x114	1	2700

* Gable - delivered premounted

Log Profiles	
Profile	Profile

28x114	
28x57	
28x114	

Windboard

① Windboard Assembly 1



② Windboard Assembly 2

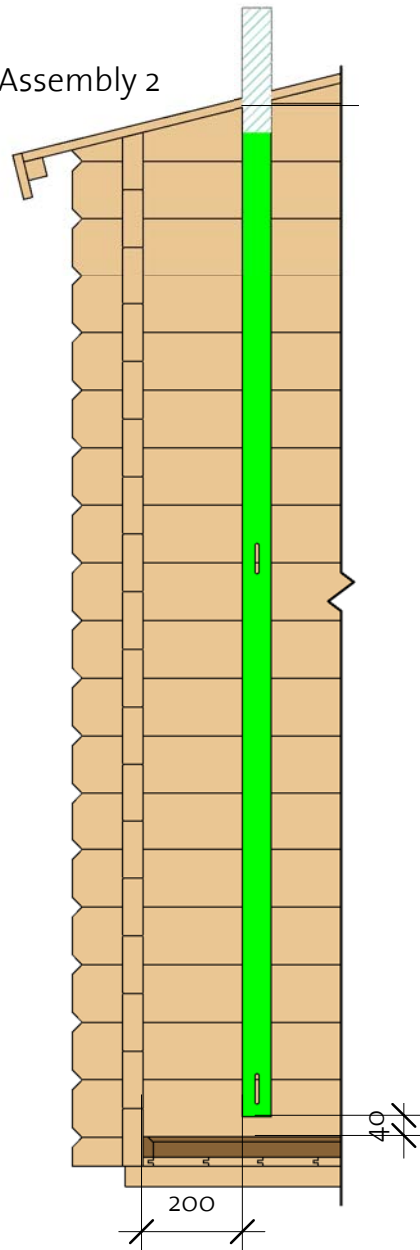

③ Windboard Assembly 3

